



Installation Notice:

The sensor must be installed in a manner that does not allow it to move. It must be at least 4" below the driving surface.

Overview

To ensure a reliable installation, a test should be done on site to determine a sensor installation location that will provide the desired detection area without picking up the gate. This is done easily by temporarily securing the sensor on top of the driving surface (preferably in the center of the driving surface) and connecting it to the DSP-14M. The DSP-14M can be temporarily placed anywhere where 8VDC to 48VDC power is available for powering the assembly. Once all wiring connections are complete and a setting has been changed to force a reset without any vehicles around the gate and sensor, the sensor location can be tested.

Testing consists of cycling the gate several times to ensure that the gate is not detected by the sensor. If the gate is detected, the sensor can be positioned further away from the gate or, if the sensor cannot be moved further away due to other obstructions, the sensitivity can be turned down. Now, a vehicle should be driven toward the sensor to observe where vehicle detection occurs and where it ends to verify your desired detection area. Be aware that larger vehicles will be detected further away than smaller vehicles. There is typically a two-foot to three-foot difference between a large SUV and a small car with the sensor being more sensitive to the SUV. Be sure to test a vehicle as far off to the side as possible to ensure vehicles not centered in the driving surface will be reliably detected. If the sensitivity is turned up to get the desired detection area, be sure to go back and check if the gate is still not detected.

Once a good sensor location has been identified, mark the location and you are now ready to perform the final install steps. The sensor can be mounted in any orientation and the sensor and wire can be direct buried. For brevity and clarity, this document only describes a vertical installation with a saw cut for the lead-in cable and a trench in horizontal installation using conduit. Many other installation methods are possible.

For the vertical installation, core drill a 1" or larger hole at the marked location to a depth of at least 4" (6" is recommended). **NOTE: Unstable operation may occur if the sensor is not at least 4" down from the top of the roadway**

Diablo Controls

Copyright © 2021-2023

Document: D79E4ADE0B77B02DB1990FF049E9E0B3902250D480F82CB1F8C8778

Released: January 19, 2023

DSP-14 Install Instructions

surface. Make a single $\frac{1}{4}$ " wide saw cut, a minimum of 2" deep, from the side of the driving surface to the drilled sensor location. Place the sensor at the bottom of the drilled hole and fill the hole with sand to within 1 $\frac{1}{2}$ " of the driving surface. **Do not install the sensor directly into the saw slot as this will void the warranty.** Any movement of the sensor after installation may cause false calls or lock ups. Use a sealant to incase the sensor and lead-in cable in the saw slot. There should be a minimum of 1 $\frac{1}{2}$ " of sealant above the sensor hole and the lead-in cable. Route the lead-in cable from the edge of the driving surface to the gate operator following local codes.

Finally, install the DSP-14M within the operator. Connect the DSP-14S lead-in cable. Terminate the Normally Open (Relay NO) or Normally Closed (Relay NC) and the relay common (Relay COM) to the appropriate points within the operator. Connect power to the DSP-14M. Change any DIP switch for two seconds and then set it back to its original setting with no vehicles in the detection area. This will reset the DSP-14M. Test for no detection of gate movement and proper detection of vehicles. Congratulations, you are now ready for operation.

NOTE: Anytime that the sensitivity setting is changed, the detector will automatically reset itself. Make sure that no vehicle is in the detection area when this reset occurs. The red LED will flash, until the automatic reset occurs.

Now that you know what the plan is, let's take this step by step:

Step 1 Identify Parts

DSP-14S (Sensor)



DSP-14M (Master)



Step 2

Locate the center of the driving surface and securely place the DSP-14S sensor on the surface. Distance from the gate will depend on several factors (motion of gate: slide or swing - gate materials: steel, aluminum, wood, iron, etc. - size of the gate). A good starting distance is 12 feet away from the gate, if possible.

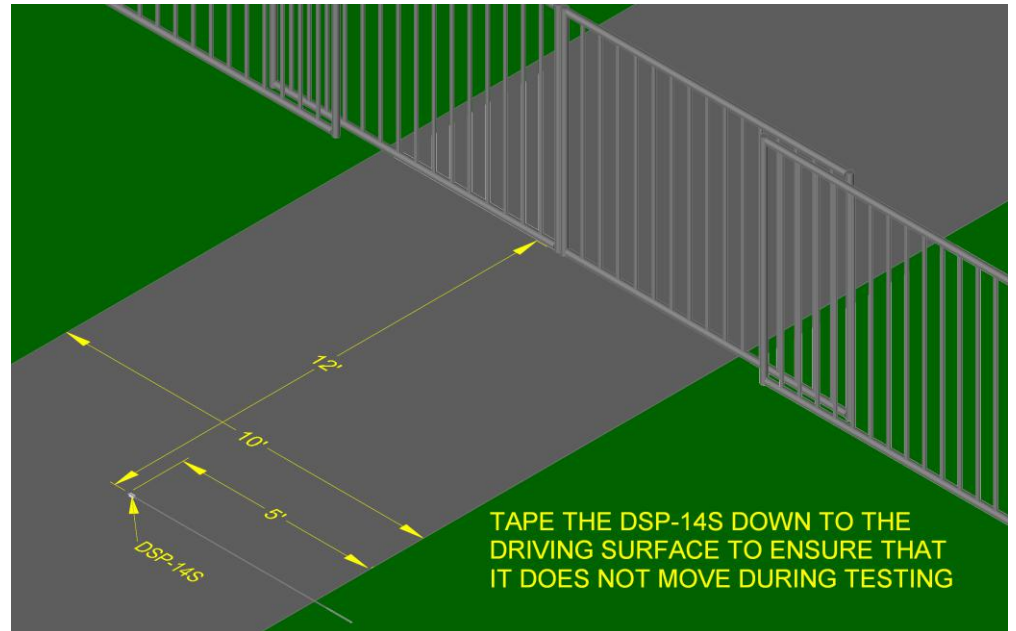

DSP-14 Install Instructions

Step 3 Find a Location where the DSP-14M can be temporarily set and powered up for sensor location testing.

Step 4 Connect the power wires to the five-position terminal block as shown. Connect the DSP-14S lead-in cable to the four-position terminal block with the colored wires attached as shown.

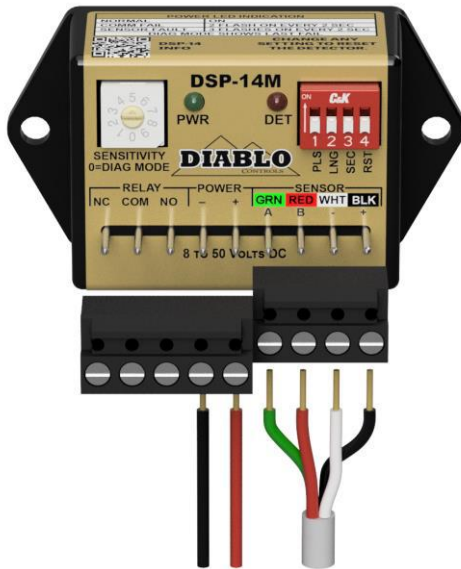

Step 5 Set the sensitivity to 5 and all DIP switches to OFF as shown. Then perform a detector reset by changing one DIP switch for two seconds and then setting it back.



Step 6 Cycle the gate several times to verify that the gate is not detected. If it is not detected, the sensor can be moved closer to the gate if needed. If detected, move the sensor further away. If it cannot be moved further, turn down the sensitivity and retest.

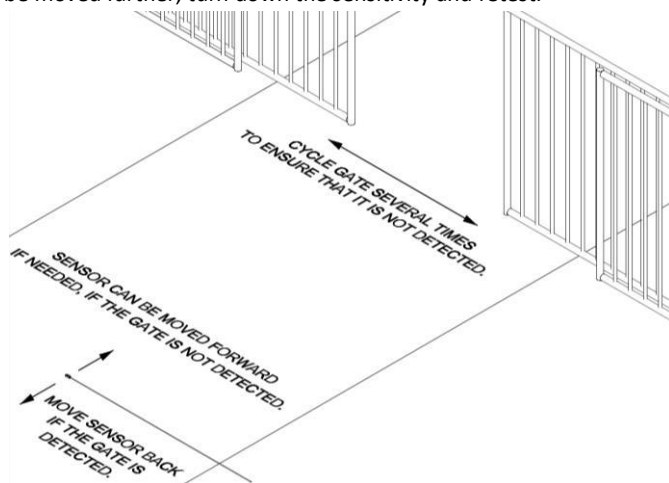

Step 7 Use a vehicle to confirm that a vehicle is detected at the desired locations. Be sure to test being as far as possible to both sides for the driving surface. If you need to turn up the sensitivity, retest for gate detection.

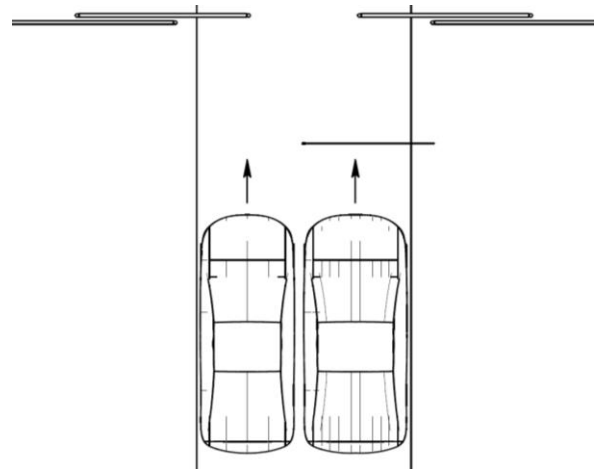

DSP-14 Install Instructions

Step 8 There are many possible installation orientations. Each with its own installation technique. The saw cut method is common for existing driving surfaces. At the location determined in the prior steps, core drill a 1" to 2" hole, 6" deep. Then make a single 1/4" saw cut, a minimum of 2" deep, from the edge of the driving surface to drilled hole.

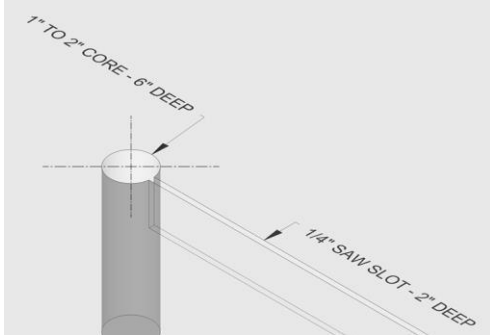

Step 9 Install the DSP-14S sensor at the bottom of the hole as shown. Fill the sensor hole with sand to within 1 1/2" of the surface. Install a 1" piece of backer rod every 12" to hold the lead-in cable at the bottom of the saw slot. Fill the hole and the saw slot with an appropriate sealant for the driving surface.

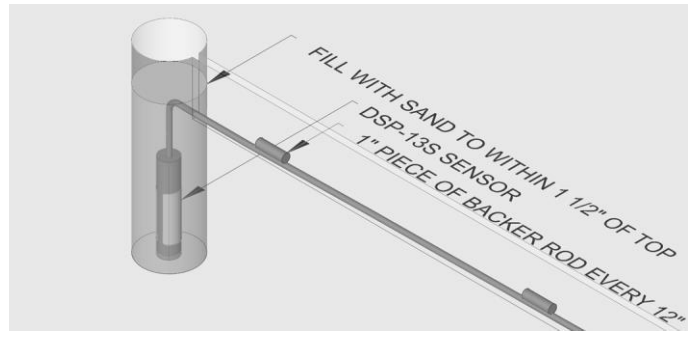

Step 8 Alternate and Step 9 Alternate A horizontal installation method can be used if trenching to the determined sensor location is possible. Install a capped, non-metallic conduit, at least 4" from the top of the driving surface, from the determined sensor location to a junction box. Wrap the sensor with some soft, flexible material (cloth, foam rubber, etc.). Measure how far out the sensor needs to be from the inside of the junction box and mark this distance on the lead-in cable. Then, using the lead-in cable, push the sensor out to the desired distance.

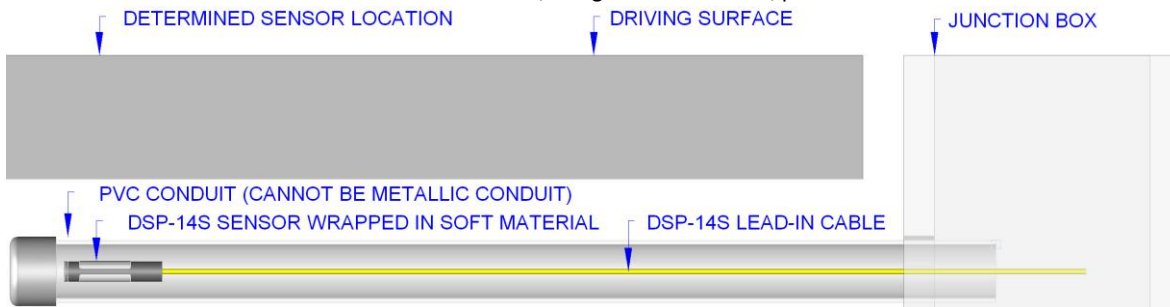

Step 10 Run the lead-in cable from the exit point in or under the driving surface to the operator. Installing a conduit will provide an additional layer of protection. Locate a position within the operator to mount the DSP-14M. This position should allow the LEDs to be seen and allow access to the sensitivity setting and DIP switches.

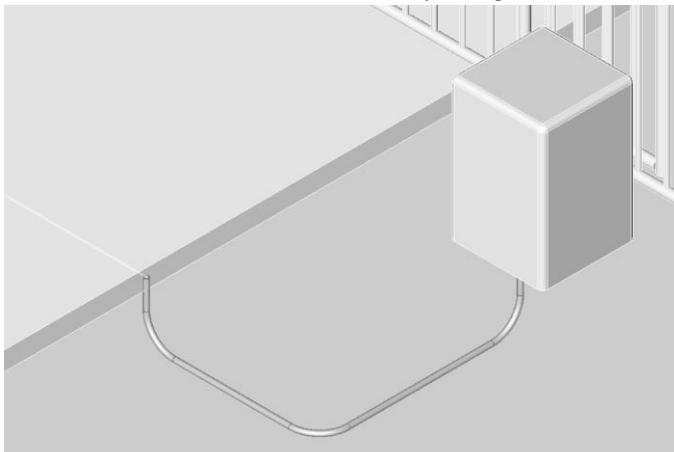

Step 11 Locate a position within the operator to mount the DSP-14M and then finish the wiring. Most domestic built operators will use the Common (COM) and the Normally Open (NO) connections (as shown). Most foreign built operators will use the Common (COM) and the Normally Closed (NC) connections.

